

# HF3505/HF3505A

# FOG-LAMP CONTROLLER



### Typical Applications

Rear Fog Lamp control

### Features

- Special integrate circuit, good performance
- Special high-performance contacts, ultra-long electrical endurance
- Surface mounting technology, advanced craftwork
- Solid base design, stable structure
- Ingress protection: IP52

### TYPE

Type	Product series name	Dimensions	Main characteristics
HF3505	Fog-lamp controller	(30 × 30 × 30)mm	2 tunnel enabling signal
HF3505A	Fog-lamp controller	(30 × 30 × 30)mm	3 tunnel enabling signal with reset (negative edge) function

### CHARACTERISTICS

Nominal Voltage		12VDC
Operating voltage range		9VDC to 16VDC
Nominal load	Resistive load	15A 13.5VDC
	Lamp load	5A 13.5VDC
Contact voltage drop		150mV 5A
Electrical endurance		5×10 <sup>4</sup> OPS (at rated load)
Ambient temperature		-40°C to 85°C
Vibration resistance		10Hz to 200Hz 49m/s <sup>2</sup>
Shock resistance		196m/s <sup>2</sup>
Unit weight		Approx.30g
Mechanical data	Cover retention	160N min.
	Terminal retention	100N min.

### ORDERING INFORMATION

Type	HF3505 / HF3505A/ Suffix(A-Z) is for specific extending application	12	-G	-B	(XXX)
Nominal voltage	12: 12VDC				
Trigger level	G: High level start up L: Low level start up				
Mounting mode	B: With bracket Nil: Without bracket				
Customer special code					



HONGFA RELAY

ISO9001, ISO/TS16949, ISO14001, OHSAS18001, IECQ QC 080000 CERTIFIED

2012 Rev. 1.01

Outline Dimensions

HF3505/12-□(XXX)

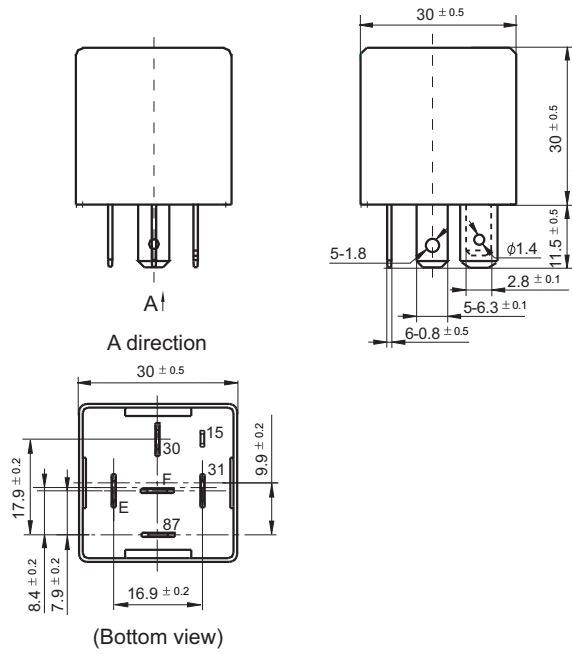

HF3505/12-□-B(XXX)

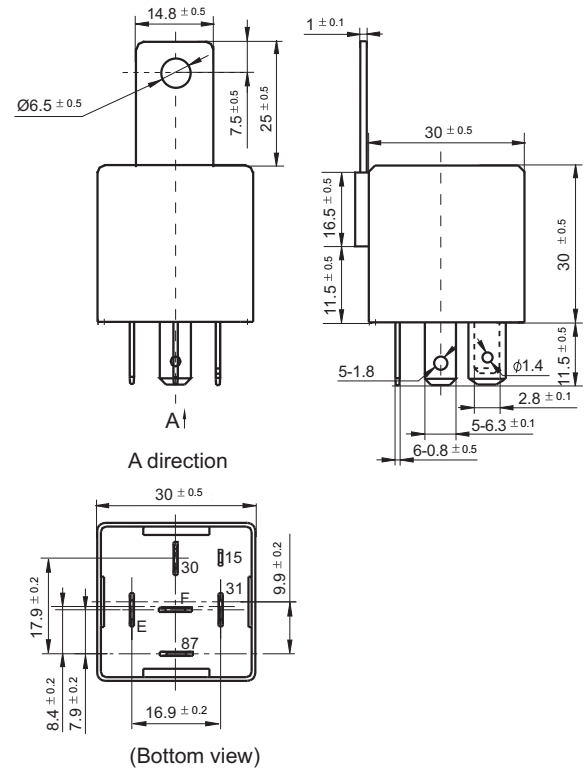

HF3505A/12-□(XXX)

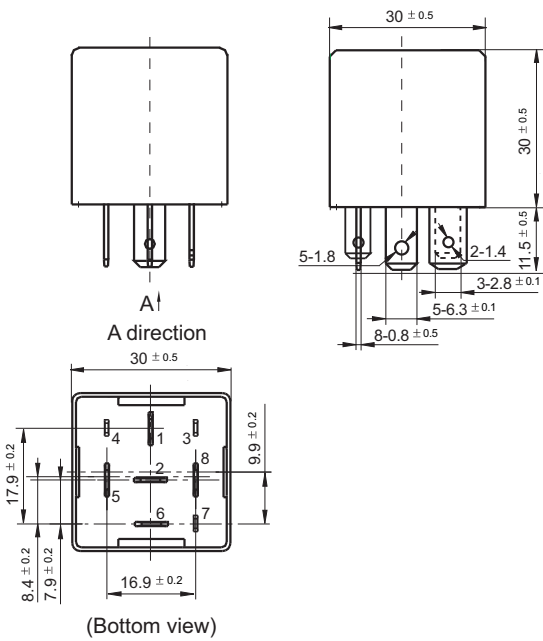

HF3505A/12-□-B(XXX)

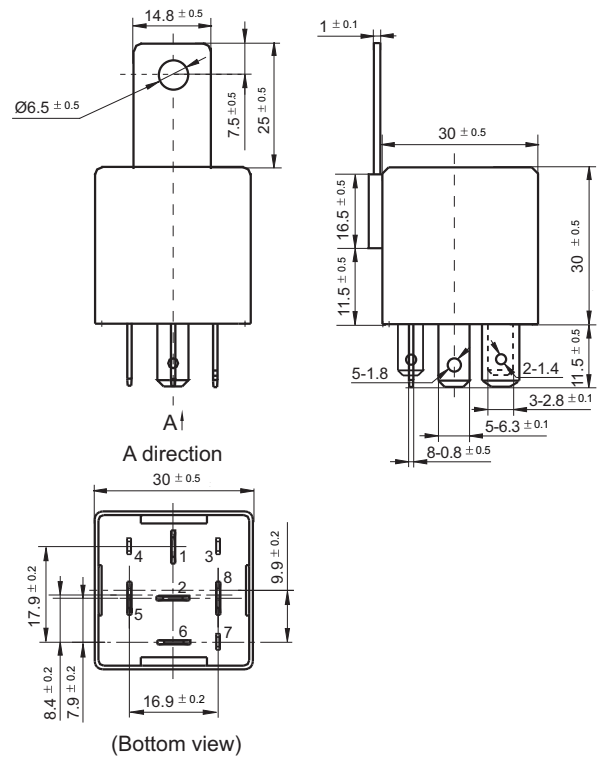

Wiring Diagram

Logic Diagram

HF3505

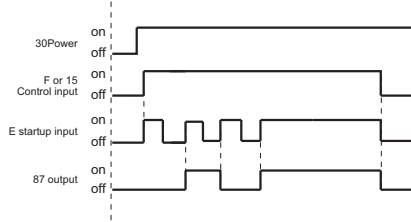
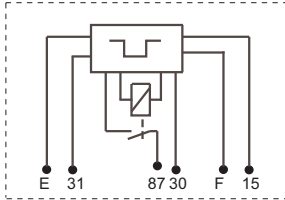

- 1) As shown in left diagram, for HF3505, the terminal 30 is connected with positive electrode of power supply, the terminal 31 is connected with negative electrode of power supply, the terminal F or terminal 15 is connected with switch, terminal 87 is connected with load.
- 2) Fog lamp energized control: When terminal 15 or F is at position of ready to connect (high voltage 9VDC to 16VDC), switch signal terminal E will change the connection of lamp load from off to on or from on to off when receive a signal. And the control will be changed along with the change of signal. The detail is as shown on left logic control diagram.

HF3505A

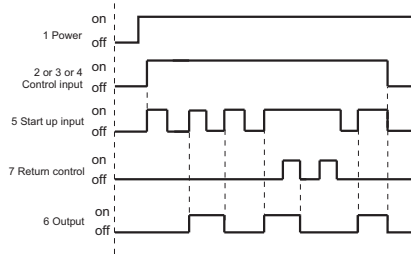
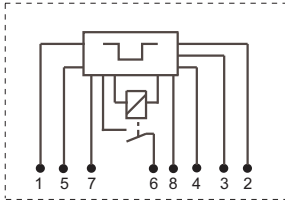

- 1) The terminal 1 is connected with positive electrode of power supply, the terminal 8 is connected with negative electrode of power supply, the terminal 2, 3, 4 is the signal input terminal, terminal 5 is the input terminal to start up or shut down signal, terminal 6 is the connection terminal for load. Terminal 7 is the input for reposition signal.
- 2) Fog lamp energized control: When any one of terminals 2, 3, 4 receive the function signal (high voltage 9VDC to 16VDC), and the terminal 5 receive the start-up terminal (effective for comes-up), then the lamp load will change from off to on, on the contrary the lamp load will change from on to off. The lamp condition will be changed along with the change of signal. The detail is as shown on logic control diagram.

Disclaimer

This datasheet is for the customers' reference. All the specifications are subject to change without notice.

We could not evaluate all the performance and all the parameters for every possible application. Thus the user should be in a right position to choose the suitable product for their own application. If there is any query, please contact Hongfa for the technical service. However, it is the user's responsibility to determine which product should be used only.