

HF18FF

MINIATURE INTERMEDIATE POWER RELAY



File No.:E133481



File No.:R50147087



File No.:CQC09002030026 (DC type)
CQC09002030027 (AC type)



Features

- 7A switching capability (2C, 3C type)
- 1.5kV dielectric strength (between coil and contacts)
- Gold plated contact available
- Conform to the CE low voltage directive
- Sockets available
- 2 to 4 pole configurations
- Environmental friendly product (RoHS compliant)
- Outline Dimensions: (28.0 x 21.5 x 35.0) mm

CONTACT DATA

Contact arrangement	2C, 3C	4C
Contact resistance	100mΩ max.(at 1A 6VDC)	
Contact material	See ordering info.	
Contact rating (Res. load)	7A 250VAC/30VDC	5A 250VAC/30VDC
Max. switching voltage	250VAC / 30VDC	
Max. switching current	7A	5A
Max. switching power	210W 1750VA	150W 1250VA
Mechanical endurance	2 x 10 ⁷ OPS	
Electrical endurance	1 x 10 ⁵ OPS (See approval reports for more details)	

CHARACTERISTICS

Insulation resistance	1000MΩ (at 500VAC)	
Dielectric strength	Between coil & contacts	1500VAC 1min
	Between open contacts	1000VAC 1min
	Between contact sets	1500VAC 1min
Operate time (at nomi. volt.)	DC type: 25ms max.	
Release time (at nomi. volt.)	DC type: 25ms max.	
Temperature rise (no-load, at nomi.volt.)	60K max.	
Shock resistance	Functional	98m/s ²
	Destructive	980m/s ²
Vibration resistance	10Hz to 55Hz 1mm DA	
Humidity	5% to 85% RH	
Ambient temperature	-40°C to 70°C	
Termination	PCB, Plug-in	
Unit weight	Approx. 37g	
Construction	Dust protected	

Notes: 1) The data shown above are initial values.
2) UL insulation system: Class A

COIL

Coil power	DC type: Approx. 0.9W to 1.1W; AC type: Approx. 1.2VA to 1.8VA
------------	---

COIL DATA

at 23°C

Nominal Voltage VDC	Pick-up Voltage VDC max.	Drop-out Voltage VDC min.	Max. Allowable Voltage VDC	Coil Resistance Ω
5	4.0	0.50	5.5	27.5 x (1±10%)
6	4.8	0.60	6.6	40 x (1±10%)
12	9.6	1.20	13.2	160 x (1±10%)
24	19.2	2.40	26.4	650 x (1±10%)
48	38.4	4.80	52.8	2600 x (1±15%)
110	88.0	11.0	121	11000 x (1±15%)

Nominal Voltage VAC	Pick-up Voltage VAC max.	Drop-out Voltage VAC min.	Max. Allowable Voltage VAC	Coil Resistance Ω
6	4.80	1.80	6.6	11.5 x (1±10%)
12	9.60	3.60	13.2	46 x (1±10%)
24	19.2	7.20	26.4	184 x (1±10%)
48	38.4	14.4	52.8	735 x (1±10%)
120	96.0	36.0	132	4550 x (1±15%)
220/240	176.0	72.0	264	14400 x (1±15%)

SAFETY APPROVAL RATINGS

UL/CUL	2 Form C	7A 250VAC/30VDC
	3 Form C 4 Form C	5A 250VAC/30VDC
TÜV	2 Form C 3 Form C	7A 250VAC/30VDC
	4 Form C	5A 250VAC/30VDC

Notes: Only some typical ratings are listed above. If more details are required, please contact us.



HONGFA RELAY

ISO9001, ISO/TS16949, ISO14001, OHSAS18001, IECQ QC 080000 CERTIFIED

2012 Rev. 1.01

ORDERING INFORMATION

Type	HF18FF / A 012 -2Z 1 G D (XXX)						
Coil voltage form	A: AC Nil: DC						
Coil voltage	DC: 5VDC to 110VDC AC: 6VAC to 240VAC						
Contact arrangement	2Z: 2 Form C 3Z: 3 Form C 4Z: 4 Form C						
Mounting Termination (See the following)	1: Socket 2: PCB 5: Flange-Mounting						
Contact material	T: AgSnO ₂ Nil: AgCe G: AgCe + Au plated TG: AgSnO ₂ + Au plated						
LED	D: With LED Nil: Without LED						
Customer special code							

Notes: 1) We also can supply the special type with terminals numbered 1,4,5,8,9,12,13,14 for 2 poles.

OUTLINE DIMENSIONS, WIRING DIAGRAM AND PC BOARD LAYOUT

Unit: mm

Outline Dimensions

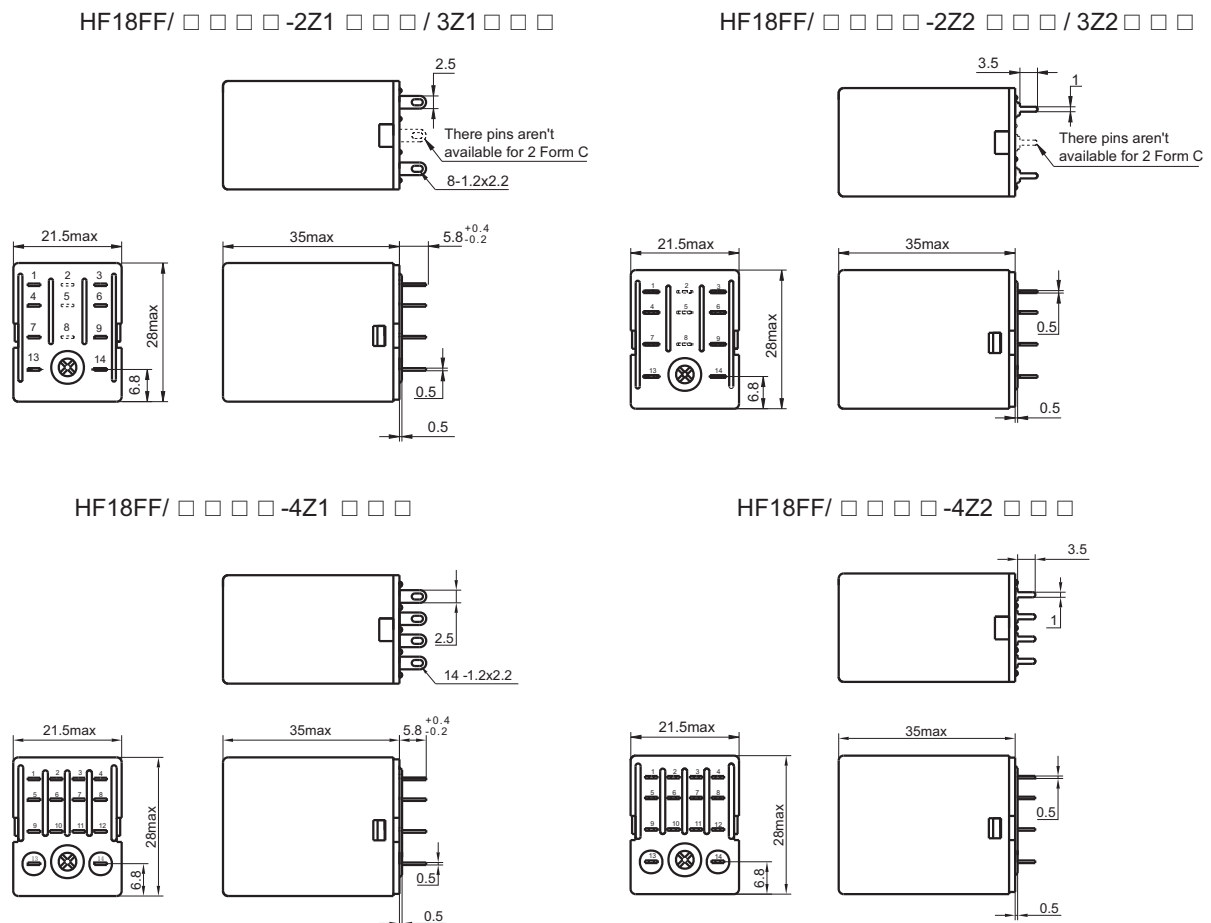

OUTLINE DIMENSIONS, WIRING DIAGRAM AND PC BOARD LAYOUT

Unit: mm

HF18FF/ □ □ □ □ -4Z5 □ □ □

Outline Dimensions

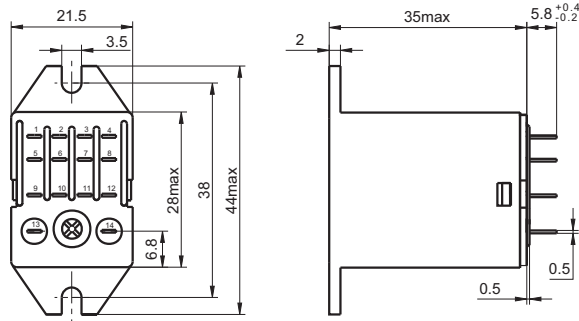

Mounting Holes



PCB Layout (Bottom view)

2 Form C

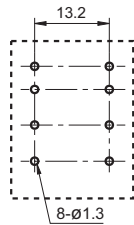

3 Form C

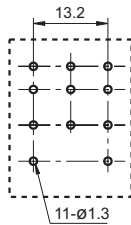

4 Form C

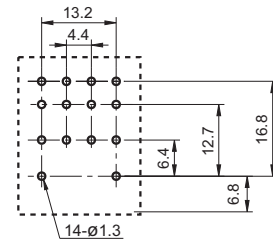

Wiring Diagram (Bottom view)

2 Form C

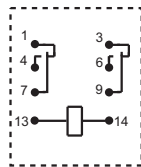

3 Form C

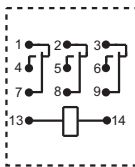

4 Form C

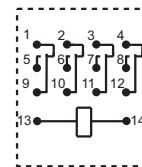

2 Form C (With LED)

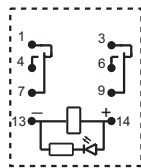

3 Form C (With LED)

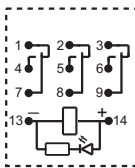

4 Form C (With LED)

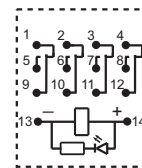

Remark: For AC parts with diode, the positive and negative pole markings on wiring diagram are not applicable.

2 Form C
(DC, With fly-wheel diode)

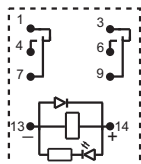

3 Form C
(DC, With fly-wheel diode)

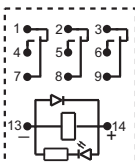

4 Form C
(DC, With fly-wheel diode)

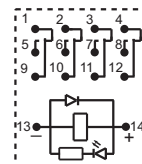

Remark: 1) In case of no tolerance shown in outline dimension: outline dimension $\leq 1\text{mm}$, tolerance should be $\pm 0.2\text{mm}$; outline dimension $> 1\text{mm}$ and $\leq 5\text{mm}$, tolerance should be $\pm 0.3\text{mm}$; outline dimension $> 5\text{mm}$, tolerance should be $\pm 0.4\text{mm}$.
2) The tolerance without indicating for PCB layout is always $\pm 0.1\text{mm}$.

CHARACTERISTIC CURVES

MAXIMUM SWITCHING POWER
(2, 3 Form C)

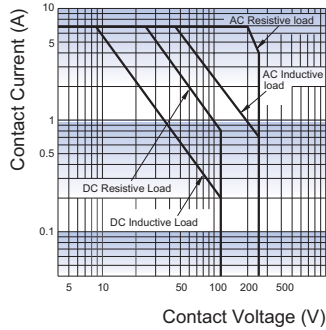

MAXIMUM SWITCHING POWER
(4 Form C)

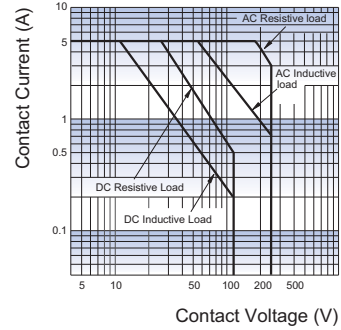

Relay Sockets



Features







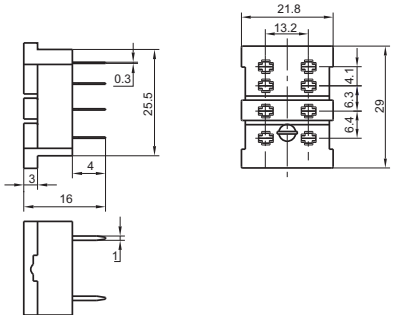
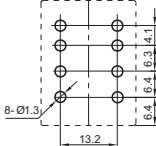

- The dielectric strength can reach 2000VAC and the insulation resistance is 1000MΩ
- Three mounting types are available: PCB mounting screw mounting and DIN rail mounting.
- With finger protection device
- Many kinds of plug-in modules are available with the function of energizing indication and wiring protection.
- Components available: retainer, marker and plug-in module
- Environmental friendly product (RoHS compliant)

CHARACTERISTICS

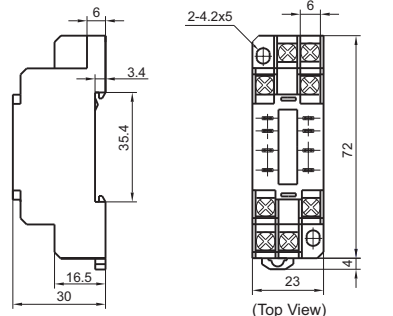
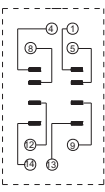
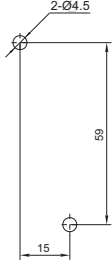
Type	Nominal Voltage	Nominal Current	Ambient Temperature	Dielectric Strength min.	Screw Torque	Wire Strip Length
18FF-2Z-A2	250VAC	7A	-40 °C to 70°C	2000VAC	—	—
18FF-2Z-C1	250VAC	7A	-40 °C to 70°C	2000VAC	0.8N · m	7mm
18FF-2Z-C2	250VAC	7A	-40 °C to 70°C	2000VAC	0.8N · m	7mm
18FF-2Z-C4	250VAC	7A	-40 °C to 70°C	2000VAC	0.6N · m	7mm
18FF-2Z-C5	250VAC	7A	-40 °C to 70°C	2000VAC	0.6N · m	7mm
18FF-2Z-C6	250VAC	7A	-40 °C to 70°C	2000VAC	0.6N · m	7mm
18FF-2Z-C7	250VAC	7A	-40 °C to 70°C	2000VAC	0.6N · m	7mm
18FF-2Z-C8	250VAC	7A	-40 °C to 70°C	2000VAC	0.6N · m	7mm
18FF-3Z-C1	250VAC	7A	-40 °C to 70°C	2000VAC	0.8N · m	7mm
18FF-3Z-C4	250VAC	7A	-40 °C to 70°C	2000VAC	0.6N · m	7mm
18FF-3Z-C5	250VAC	7A	-40 °C to 70°C	2000VAC	0.6N · m	7mm
18FF-4Z-A2	250VAC	7A	-40 °C to 70°C	2000VAC	—	—
18FF-4Z-C1	250VAC	7A	-40 °C to 70°C	2000VAC	0.8N · m	7mm
18FF-4Z-C2	250VAC	7A	-40 °C to 70°C	2000VAC	0.8N · m	7mm
18FF-4Z-C4	250VAC	7A	-40 °C to 70°C	2000VAC	0.6N · m	7mm
18FF-4Z-C5	250VAC	7A	-40 °C to 70°C	2000VAC	0.6N · m	7mm
18FF-4Z-C6	250VAC	7A	-40 °C to 70°C	2000VAC	0.6N · m	7mm
18FF-4Z-C7	250VAC	7A	-40 °C to 70°C	2000VAC	0.6N · m	7mm
18FF-4Z-C8	250VAC	7A	-40 °C to 70°C	2000VAC	0.6N · m	7mm

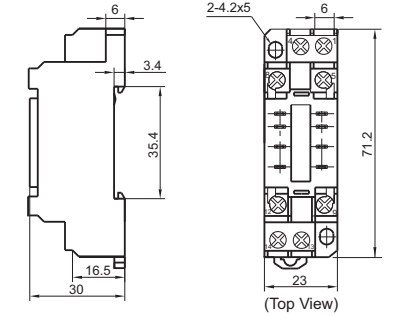
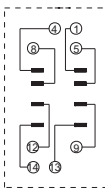
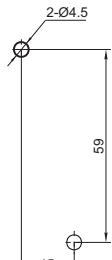

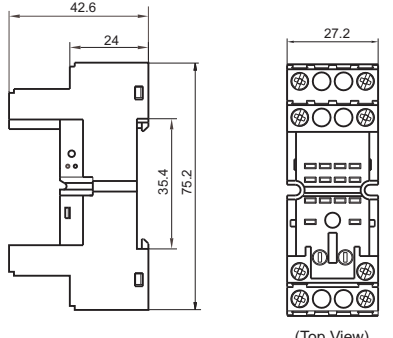
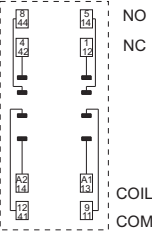
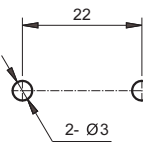

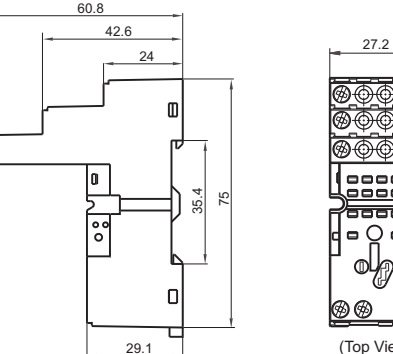
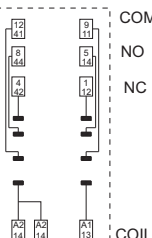
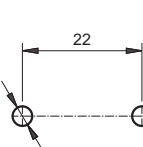

OUTLINE DIMENSIONS, WIRING DIAGRAM AND PC BOARD LAYOUT

Unit: mm

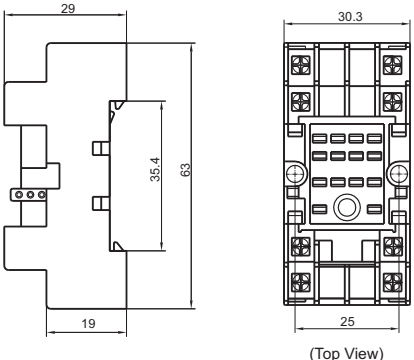
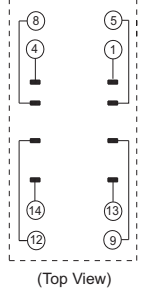
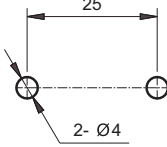
Socket	Outline Dimensions	Wiring Diagram	PCB Layout	Components Available
<p>18FF-2Z-A2</p>  <p>PCB Terminal, PCB mounting Applicable for 2 poles</p>				<p>metallic retainer 18FF-H1</p>
<p>18FF-2Z-C1</p>  <p>Screw Terminal, DIN rail or Screw mounting, Applicable for 2 poles</p>		 <p>(Top View)</p>		<p>metallic retainer 18FF-H2 (be used in sets)</p>
<p>18FF-2Z-C2</p>  <p>Screw Terminal, DIN rail or Screw mounting, With finger protection device Applicable for 2 poles</p>		 <p>(Top View)</p>		<p>metallic retainer 18FF-H2 (be used in sets)</p>
<p>18FF-2Z-C4</p>  <p>Screw Terminal, DIN rail or Screw mounting, With finger protection device Applicable for 2 poles</p>		 <p>(Top View)</p>		<p>plastic retainer 18FF-H4 metallic retainer 18FF-H5 marker 18FF-M1 plug-in module HFAA to HFHU*</p>
<p>18FF-2Z-C5</p>  <p>Screw Terminal, DIN rail or Screw mounting, With finger protection device Applicable for 2 poles</p>		 <p>(Top View)</p>		<p>plastic retainer 18FF-H4 metallic retainer 18FF-H5 marker 18FF-M1 plug-in module HFAA to HFHU*</p>

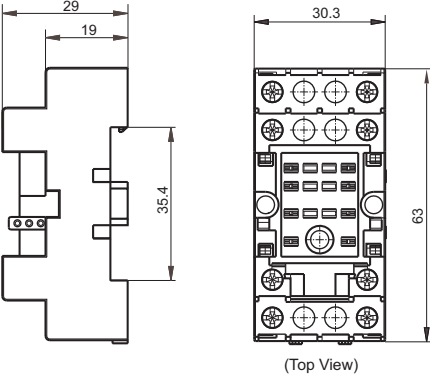
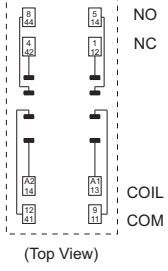
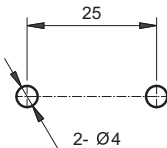

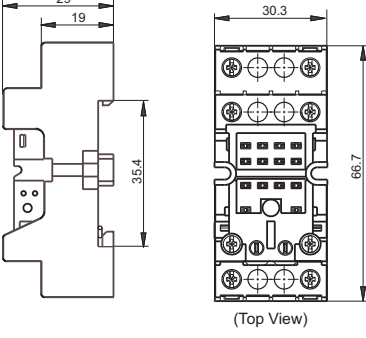
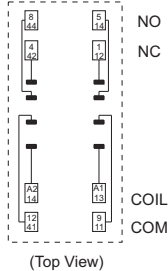
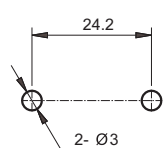

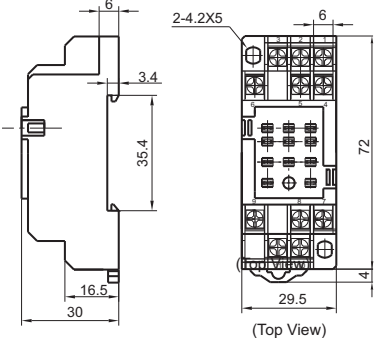
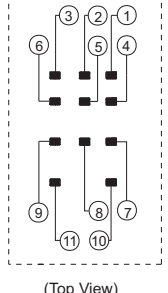
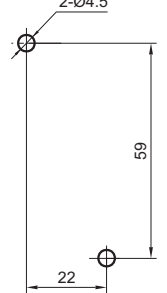

OUTLINE DIMENSIONS, WIRING DIAGRAM AND PC BOARD LAYOUT

Unit: mm

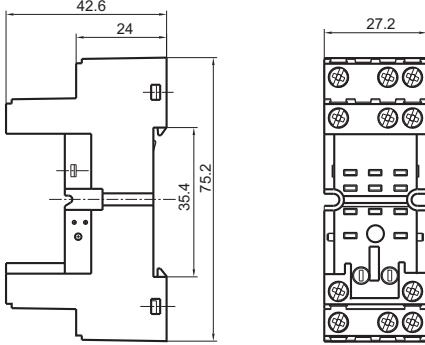
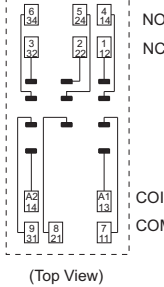
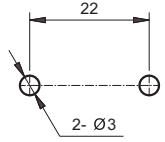
Socket	Outline Dimensions	Wiring Diagram	PCB Layout	Components Available
<p>18FF-2Z-C6</p>  <p>Screw Terminal, DIN rail or Screw mounting, Applicable for 2 poles</p>	 <p>(Top View)</p>	 <p>(Top View)</p>		<p>metallic retainer 18FF-H6 (be used in sets)</p> <p>marker 18FF-M2</p>
<p>18FF-2Z-C7</p>  <p>Screw Terminal, DIN rail or Screw mounting, With finger protection device Applicable for 2 poles</p>	 <p>(Top View)</p>	 <p>(Top View)</p>		<p>metallic retainer 18FF-H5</p> <p>marker 18FF-M2</p>
<p>18FF-2Z-C8</p>  <p>Screw Terminal, DIN rail or Screw mounting, With finger protection device Applicable for 2 poles</p>	 <p>(Top View)</p>	 <p>(Top View)</p>		<p>plastic retainer 18FF-H4</p> <p>marker 18FF-M3</p>
<p>18FF-3Z-C1</p>  <p>Screw Terminal, DIN rail or Screw mounting, Without finger protection device Applicable for 3 poles</p>	 <p>(Top View)</p>	 <p>(Top View)</p>		<p>metallic retainer 18FF-H2 (be used in sets)</p>

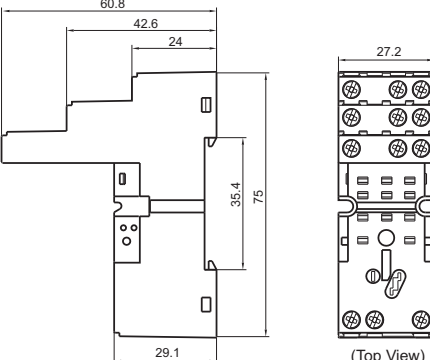
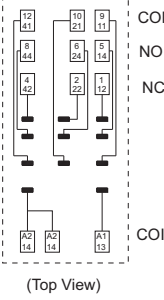
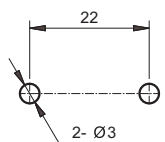

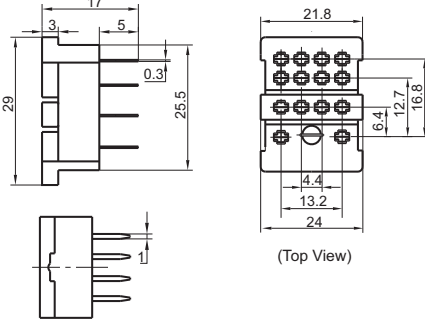
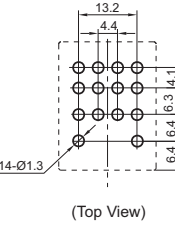

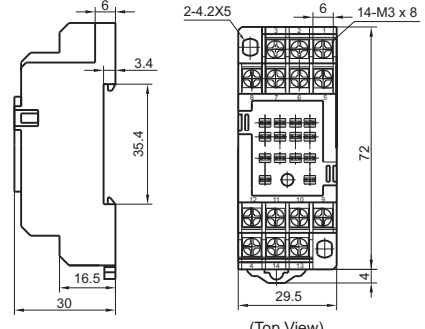
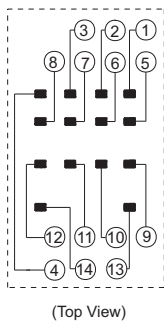
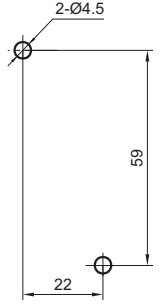

OUTLINE DIMENSIONS, WIRING DIAGRAM AND PC BOARD LAYOUT

Unit: mm

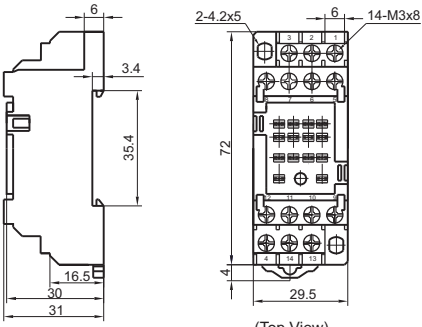
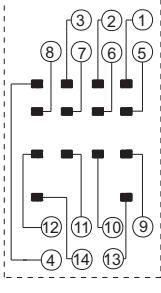
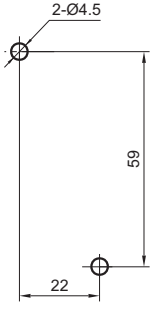
Socket	Outline Dimensions	Wiring Diagram	PCB Layout	Components Available
<p>18FF-3Z-C4</p>  <p>Screw Terminal, DIN rail or Screw mounting, With finger protection device Applicable for 3 poles</p>	 <p>(Top View)</p>	 <p>(Top View)</p>		<p>plastic retainer 18FF-H4 metallic retainer 18FF-H5 marker 18FF-M1 plug-in module HFAA to HFHU*</p>
<p>18FF-3Z-C5</p>  <p>Screw Terminal, DIN rail or Screw mounting, With finger protection device Applicable for 3 poles</p>	 <p>(Top View)</p>	 <p>(Top View)</p>		<p>plastic retainer 18FF-H4 metallic retainer 18FF-H5 marker 18FF-M1 plug-in module HFAA to HFHU*</p>
<p>18FF-4Z-A2</p>  <p>PCB Terminal, PCB mounting Applicable for 4 poles</p>	 <p>(Top View)</p>		 <p>(Top View)</p>	<p>metallic retainer 18FF-H1</p>
<p>18FF-4Z-C1</p>  <p>Screw Terminal, DIN rail or Screw mounting, Without finger protection device Applicable for 4 poles</p>	 <p>(Top View)</p>	 <p>(Top View)</p>		<p>metallic retainer 18FF-H2 (be used in sets)</p>

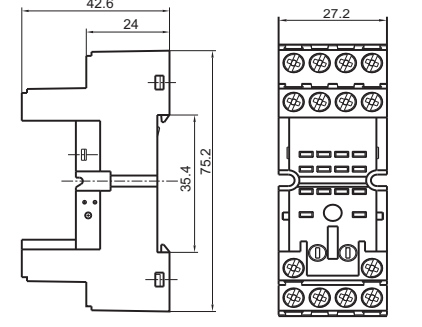
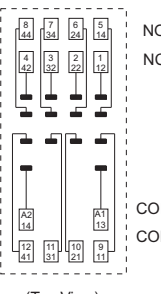
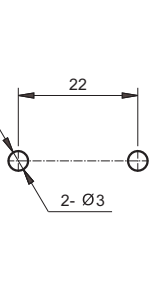

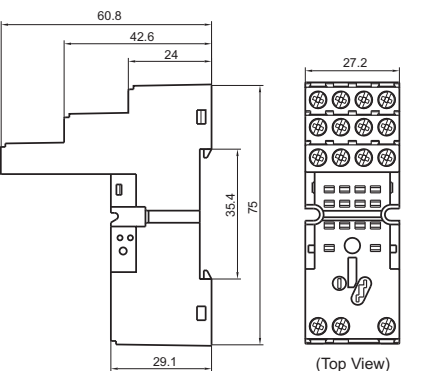
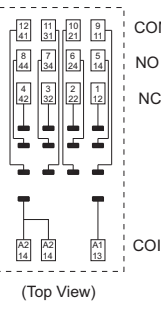
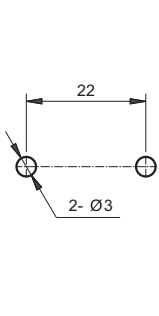
OUTLINE DIMENSIONS, WIRING DIAGRAM AND PC BOARD LAYOUT

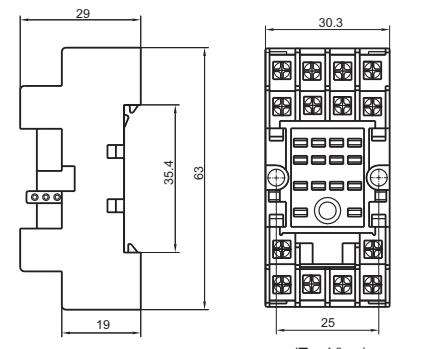
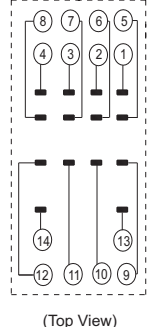
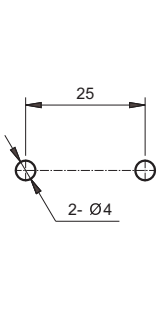
Unit: mm

Socket	Outline Dimensions	Wiring Diagram	PCB Layout	Components Available
<p>18FF-4Z-C2</p>  <p>Screw Terminal, DIN rail or Screw mounting, With finger protection device Applicable for 4 poles</p>	 <p>(Top View)</p>	 <p>(Top View)</p>		<p>metallic retainer 18FF-H2 (be used in sets)</p>
<p>18FF-4Z-C4</p>  <p>Screw Terminal, DIN rail or Screw mounting, With finger protection device Applicable for 4 poles</p>	 <p>(Top View)</p>	 <p>(Top View)</p>		<p>plastic retainer 18FF-H4 metallic retainer 18FF-H5 marker 18FF-M1 plug-in module HFAA to HFHU*</p>
<p>18FF-4Z-C5</p>  <p>Screw Terminal, DIN rail or Screw mounting, With finger protection device Applicable for 4 poles</p>	 <p>(Top View)</p>	 <p>(Top View)</p>		<p>plastic retainer 18FF-H4 metallic retainer 18FF-H5 marker 18FF-M1 plug-in module HFAA to HFHU*</p>
<p>18FF-4Z-C6</p>  <p>Screw Terminal, DIN rail or Screw mounting, Applicable for 4 poles</p>	 <p>(Top View)</p>	 <p>(Top View)</p>		<p>metallic retainer 18FF-H6 (be used in sets) marker 18FF-M2</p>

OUTLINE DIMENSIONS, WIRING DIAGRAM AND PC BOARD LAYOUT

Unit: mm

Socket	Outline Dimensions	Wiring Diagram	PCB Layout	Components Available
<p>18FF-4Z-C7</p>  <p>Screw Terminal, DIN rail or Screw mounting, With finger protection device Applicable for 4 poles</p>	<p>(Top View)</p>	<p>(Top View)</p>		<p>metallic retainer 18FF-H5</p> <p>marker 18FF-M2</p>
<p>18FF-4Z-C8</p>  <p>Screw Terminal, DIN rail or Screw mounting, With finger protection device Applicable for 4 poles</p>	<p>(Top View)</p>	<p>(Top View)</p>		<p>plastic retainer 18FF-H4</p> <p>marker 18FF-M3</p>

Notes: * Please refer to the product datasheet if plug-in module is required.

DIMENSION OF RELATED COMPONENT (AVAILABLE)

Unit: mm

Retainer

18FF-H1 (metallic retainer)

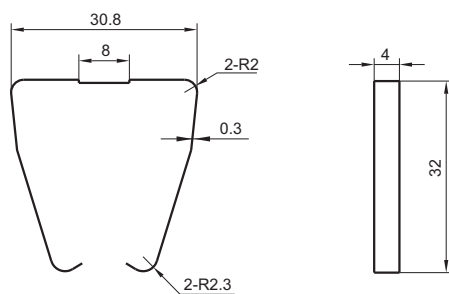

18FF-H2 (metallic retainer)

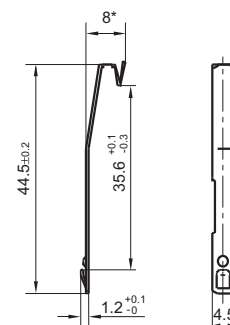

Note: 18FF-H2 retainer has to be used in sets, please pay special attention while placing the order.

DIMENSION OF RELATED COMPONENT (AVAILABLE)

Unit: mm

Retainer

18FF-H4 (plastic retainer)

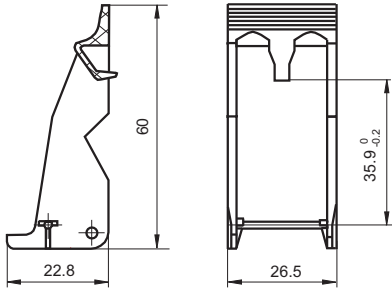

18FF-H5 (metallic retainer)

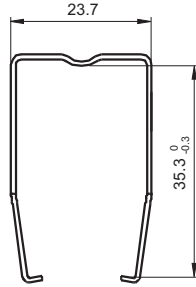

18FF-H6 (metallic retainer)

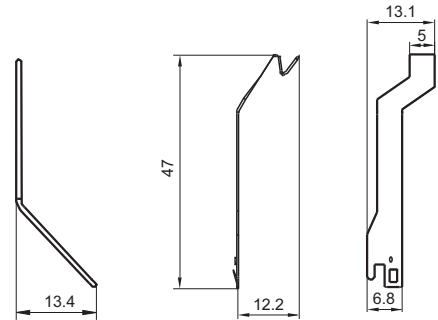

Note: 18FF-H6 retainer has to be used in sets, please pay special attention while placing the order.

Marker

18FF-M1

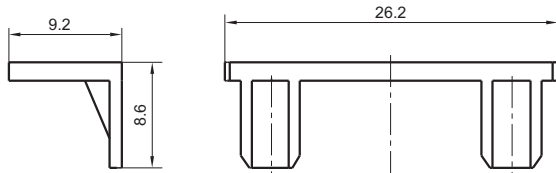

18FF-M2

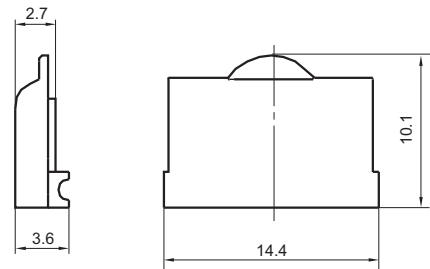

18FF-M3

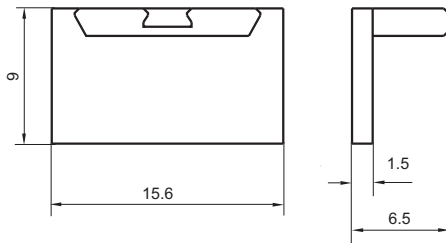

Things to be noticed when selecting sockets:

1. Please choose suitable relay socket according to the actual mounting environment, relay contact poles and terminal layout. If there is any query on selection, please contact Hongfa for the technical service.
2. Socket which can be mounted with markers is furnished with a marker; as for other related components, they should be selected separately. Please do give clear indication of the types of relay sockets and related components you choose while placing order.
3. The above is only an example of typical socket and related component type which is suitable to HF18FF relay. If you have any special requirements, please contact us.

Disclaimer

This datasheet is for the customers' reference. All the specifications are subject to change without notice. We could not evaluate all the performance and all the parameters for every possible application. Thus the user should be in a right position to choose the suitable product for their own application. If there is any query, please contact Hongfa for the technical service. However, it is the user's responsibility to determine which product should be used only.

© Xiamen Hongfa Electroacoustic Co., Ltd. All rights of Hongfa are reserved.