

# 18FF Sockets

# RELAY SOCKETS

CE

CULUS

File No.: E253370



### Features

- The dielectric strength can reach 2000VAC and the insulation resistance is 1000MΩ
- Three mounting types are available: PCB mounting screw mounting and DIN rail mounting.
- With finger protection device
- Many kinds of plug-in modules are available with the function of energizing indication and wiring protection.
- Components available: retainer, marker and plug-in module
- Applicable relay types: HF18FF/HF18FH
- Environmental friendly product (RoHS compliant)

## CHARACTERISTICS

Type	Nominal Voltage	Nominal Current	Ambient Temperature	Dielectric Strength min.	Screw Torque	Wire Strip Length
18FF-2Z-A2	250VAC	7A	-40 °C to 70 °C	2000VAC	—	—
18FF-2Z-C1	250VAC	7A	-40 °C to 70 °C	2000VAC	0.8N · m	7mm
18FF-2Z-C2	250VAC	7A	-40 °C to 70 °C	2000VAC	0.8N · m	7mm
18FF-2Z-C4	250VAC	7A	-40 °C to 70 °C	2000VAC	0.6N · m	7mm
18FF-2Z-C5	250VAC	7A	-40 °C to 70 °C	2000VAC	0.6N · m	7mm
18FF-2Z-C6	250VAC	7A	-40 °C to 70 °C	2000VAC	0.6N · m	7mm
18FF-2Z-C7	250VAC	7A	-40 °C to 70 °C	2000VAC	0.6N · m	7mm
18FF-2Z-C8	250VAC	7A	-40 °C to 70 °C	2000VAC	0.6N · m	7mm
18FF-3Z-C1	250VAC	7A	-40 °C to 70 °C	2000VAC	0.8N · m	7mm
18FF-3Z-C4	250VAC	7A	-40 °C to 70 °C	2000VAC	0.6N · m	7mm
18FF-3Z-C5	250VAC	7A	-40 °C to 70 °C	2000VAC	0.6N · m	7mm
18FF-4Z-A2	250VAC	7A	-40 °C to 70 °C	2000VAC	—	—
18FF-4Z-C1	250VAC	7A	-40 °C to 70 °C	2000VAC	0.8N · m	7mm
18FF-4Z-C2	250VAC	7A	-40 °C to 70 °C	2000VAC	0.8N · m	7mm
18FF-4Z-C4	250VAC	7A	-40 °C to 70 °C	2000VAC	0.6N · m	7mm
18FF-4Z-C5	250VAC	7A	-40 °C to 70 °C	2000VAC	0.6N · m	7mm
18FF-4Z-C6	250VAC	7A	-40 °C to 70 °C	2000VAC	0.6N · m	7mm
18FF-4Z-C7	250VAC	7A	-40 °C to 70 °C	2000VAC	0.6N · m	7mm
18FF-4Z-C8	250VAC	7A	-40 °C to 70 °C	2000VAC	0.6N · m	7mm

## OUTLINE DIMENSIONS, WIRING DIAGRAM AND PC BOARD LAYOUT

Unit: mm

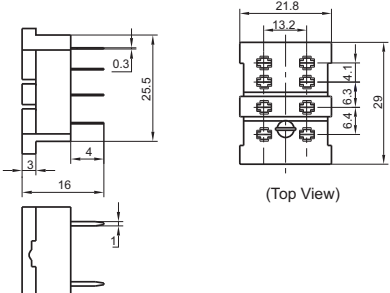
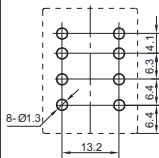
Socket	Outline Dimensions	Wiring Diagram	PCB Layout	Components Available
 <p>18FF-2Z-A2</p> <p>PCB Terminal, PCB mounting Applicable for 2 poles</p>	 <p>(Top View)</p>			<p>metallic retainer 18FF-H1</p>









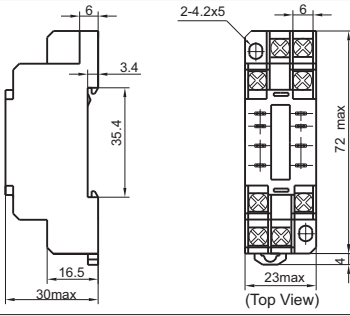
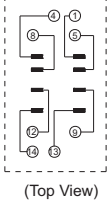
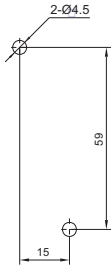

HONGFA RELAY

ISO9001, ISO/TS16949, ISO14001, OHSAS18001, IECQ QC 080000 CERTIFIED

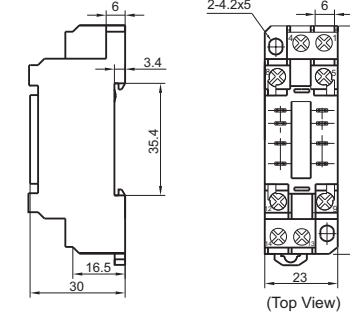
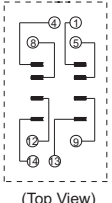
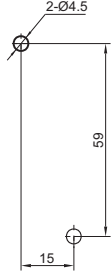
2012 Rev. 1.01

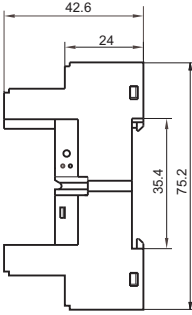
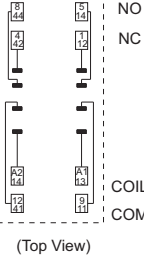
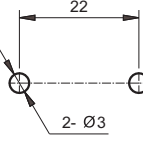

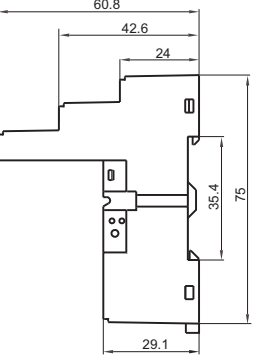
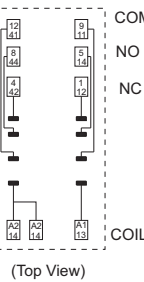
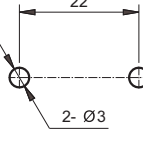

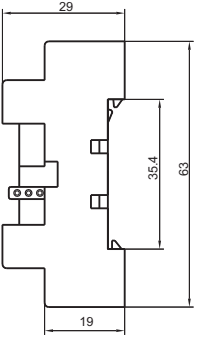
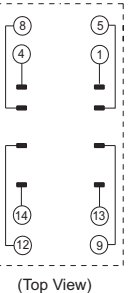
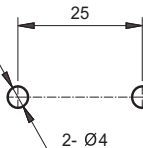

# OUTLINE DIMENSIONS, WIRING DIAGRAM AND PC BOARD LAYOUT

Unit: mm

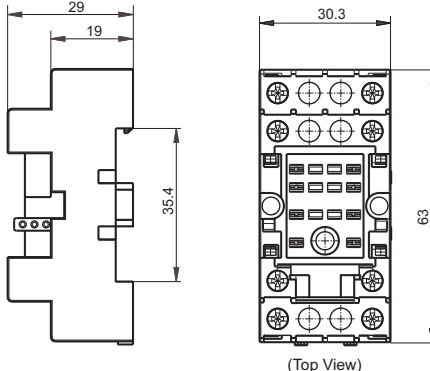
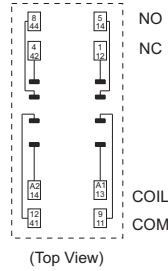
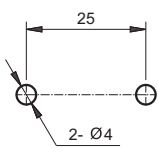
Socket	Outline Dimensions	Wiring Diagram	PCB Layout	Components Available
<p><b>18FF-2Z-C1</b></p>  <p>Screw Terminal, DIN rail or Screw mounting, Applicable for 2 poles</p>	 <p>(Top View)</p>	 <p>(Top View)</p>		<p>metallic retainer 18FF-H2 (be used in sets)</p>
<p><b>18FF-2Z-C2</b></p>  <p>Screw Terminal, DIN rail or Screw mounting, With finger protection device Applicable for 2 poles</p>	 <p>(Top View)</p>	 <p>(Top View)</p>		<p>metallic retainer 18FF-H2 (be used in sets)</p>
<p><b>18FF-2Z-C4</b></p>  <p>Screw Terminal, DIN rail or Screw mounting, With finger protection device Applicable for 2 poles</p>	 <p>(Top View)</p>	 <p>(Top View)</p>		<p>plastic retainer 18FF-H4 metallic retainer 18FF-H5 marker 18FF-M1 plug-in module HFAA to HFHU*</p>
<p><b>18FF-2Z-C5</b></p>  <p>Screw Terminal, DIN rail or Screw mounting, With finger protection device Applicable for 2 poles</p>	 <p>(Top View)</p>	 <p>(Top View)</p>		<p>plastic retainer 18FF-H4 metallic retainer 18FF-H5 marker 18FF-M1 plug-in module HFAA to HFHU*</p>
<p><b>18FF-2Z-C6</b></p>  <p>Screw Terminal, DIN rail or Screw mounting, Applicable for 2 poles</p>	 <p>(Top View)</p>	 <p>(Top View)</p>		<p>metallic retainer 18FF-H6 (be used in sets) marker 18FF-M2</p>

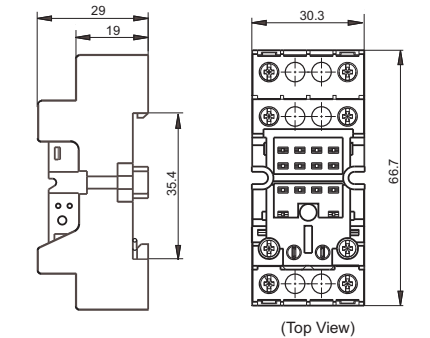
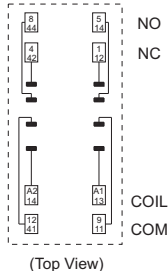
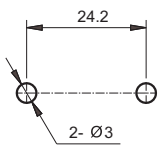

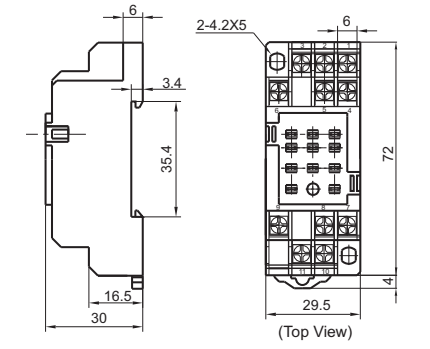
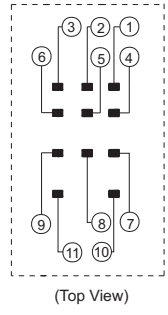
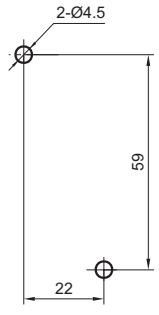

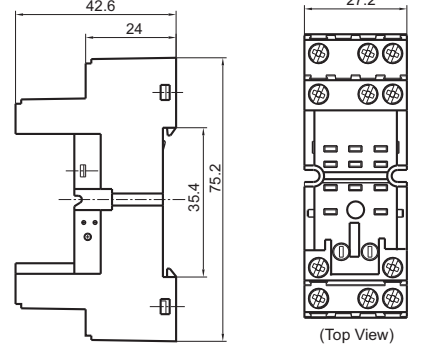
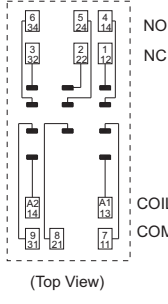
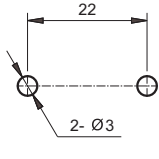

# OUTLINE DIMENSIONS, WIRING DIAGRAM AND PC BOARD LAYOUT

Unit: mm

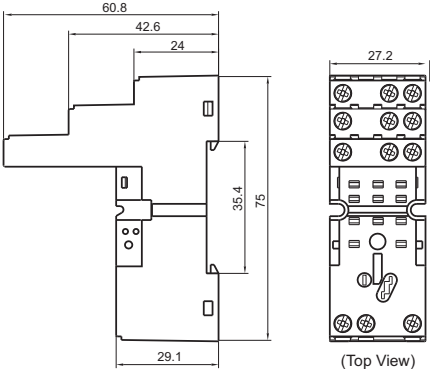
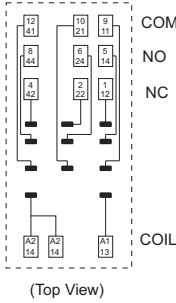
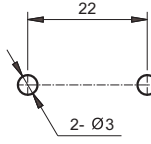
Socket	Outline Dimensions	Wiring Diagram	PCB Layout	Components Available
<p><b>18FF-2Z-C7</b></p>  <p>Screw Terminal, DIN rail or Screw mounting, With finger protection device Applicable for 2 poles</p>	 <p>(Top View)</p>	 <p>(Top View)</p>		<p>metallic retainer 18FF-H5 marker 18FF-M2</p>
<p><b>18FF-2Z-C8</b></p>  <p>Screw Terminal, DIN rail or Screw mounting, With finger protection device Applicable for 2 poles</p>	 <p>(Top View)</p>	 <p>(Top View)</p>		<p>plastic retainer 18FF-H4 marker 18FF-M3</p>
<p><b>18FF-3Z-C1</b></p>  <p>Screw Terminal, DIN rail or Screw mounting, Without finger protection device Applicable for 3 poles</p>	 <p>(Top View)</p>	 <p>(Top View)</p>		<p>metallic retainer 18FF-H2 (be used in sets)</p>
<p><b>18FF-3Z-C4</b></p>  <p>Screw Terminal, DIN rail or Screw mounting, With finger protection device Applicable for 3 poles</p>	 <p>(Top View)</p>	 <p>(Top View)</p>		<p>plastic retainer 18FF-H4 metallic retainer 18FF-H5 marker 18FF-M1 plug-in module HFAA to HFHU*</p>

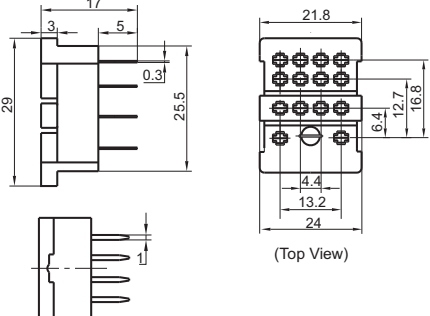
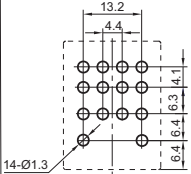

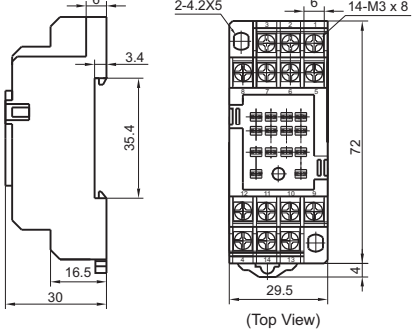
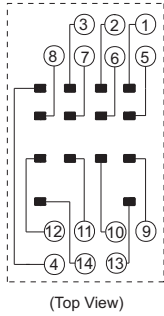
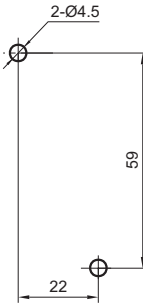

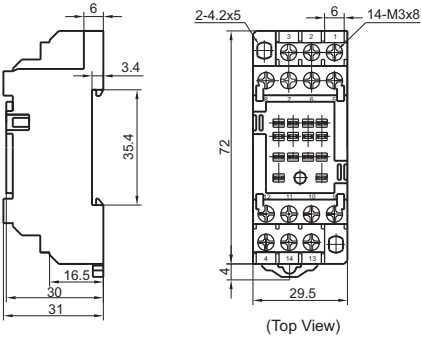
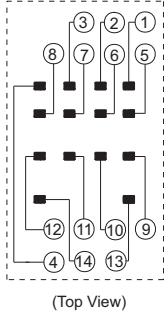
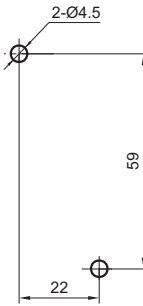

# OUTLINE DIMENSIONS, WIRING DIAGRAM AND PC BOARD LAYOUT

Unit: mm

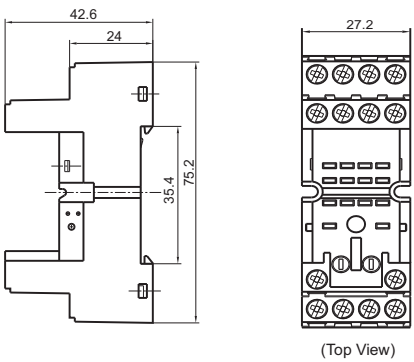
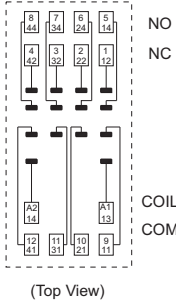
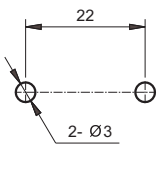
Socket	Outline Dimensions	Wiring Diagram	PCB Layout	Components Available
<p><b>18FF-3Z-C5</b></p>  <p>Screw Terminal, DIN rail or Screw mounting, With finger protection device Applicable for 3 poles</p>	 <p>(Top View)</p>	 <p>(Top View)</p>	 <p>(Top View)</p>	<p>plastic retainer 18FF-H4 metallic retainer 18FF-H5 marker 18FF-M1 plug-in module HFAA to HFHU*</p>
<p><b>18FF-4Z-A2</b></p>  <p>PCB Terminal, PCB mounting Applicable for 4 poles</p>	 <p>(Top View)</p>		 <p>(Top View)</p>	<p>metallic retainer 18FF-H1</p>
<p><b>18FF-4Z-C1</b></p>  <p>Screw Terminal, DIN rail or Screw mounting, Without finger protection device Applicable for 4 poles</p>	 <p>(Top View)</p>	 <p>(Top View)</p>	 <p>(Top View)</p>	<p>metallic retainer 18FF-H2 (be used in sets)</p>
<p><b>18FF-4Z-C2</b></p>  <p>Screw Terminal, DIN rail or Screw mounting, With finger protection device Applicable for 4 poles</p>	 <p>(Top View)</p>	 <p>(Top View)</p>	 <p>(Top View)</p>	<p>metallic retainer 18FF-H2 (be used in sets)</p>

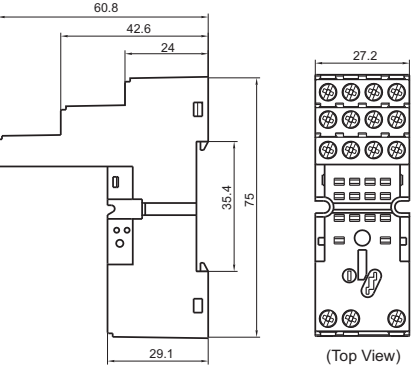
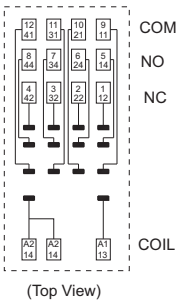
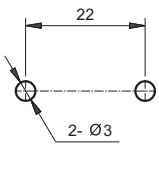
# OUTLINE DIMENSIONS, WIRING DIAGRAM AND PC BOARD LAYOUT

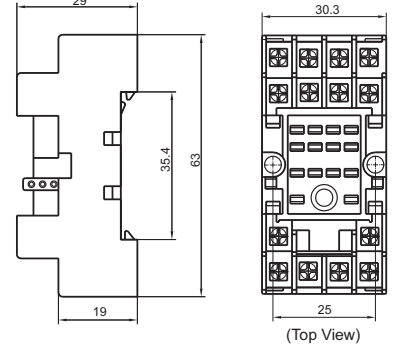
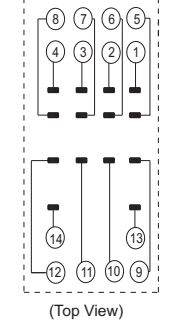
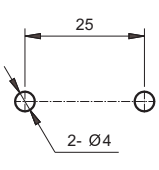
Unit: mm

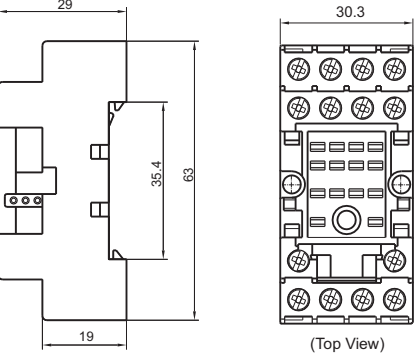
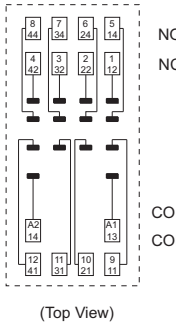
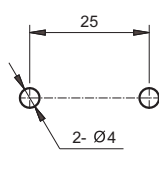
Socket	Outline Dimensions	Wiring Diagram	PCB Layout	Components Available
<p><b>18FF-4Z-C4</b></p>  <p>Screw Terminal, DIN rail or Screw mounting, With finger protection device Applicable for 4 poles</p>	 <p>(Top View)</p>	 <p>(Top View)</p>		<p>plastic retainer 18FF-H4 metallic retainer 18FF-H5</p> <p>marker 18FF-M1</p> <p>plug-in module HFAA to HFHU*</p>
<p><b>18FF-4Z-C5</b></p>  <p>Screw Terminal, DIN rail or Screw mounting, With finger protection device Applicable for 4 poles</p>	 <p>(Top View)</p>	 <p>(Top View)</p>		<p>plastic retainer 18FF-H4 metallic retainer 18FF-H5</p> <p>marker 18FF-M1</p> <p>plug-in module HFAA to HFHU*</p>
<p><b>18FF-4Z-C6</b></p>  <p>Screw Terminal, DIN rail or Screw mounting, Applicable for 4 poles</p>	 <p>(Top View)</p>	 <p>(Top View)</p>		<p>metallic retainer 18FF-H6 (be used in sets)</p> <p>marker 18FF-M2</p>
<p><b>18FF-4Z-C7</b></p>  <p>Screw Terminal, DIN rail or Screw mounting, With finger protection device Applicable for 4 poles</p>	 <p>(Top View)</p>	 <p>(Top View)</p>		<p>metallic retainer 18FF-H5</p> <p>marker 18FF-M2</p>

## OUTLINE DIMENSIONS, WIRING DIAGRAM AND PC BOARD LAYOUT

Unit: mm

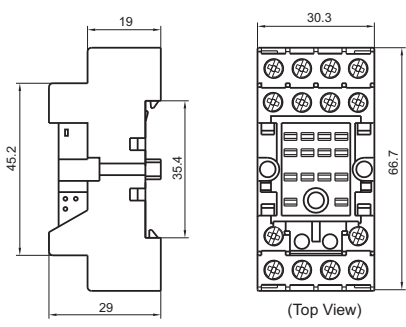
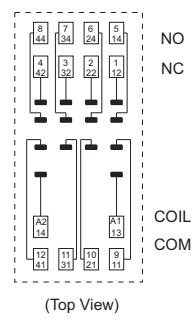
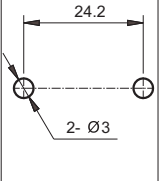
Socket	Outline Dimensions	Wiring Diagram	PCB Layout	Components Available
<p>18FF-4Z-C8</p>  <p>Screw Terminal, DIN rail or Screw mounting, With finger protection device Applicable for 4 poles</p>	 <p>(Top View)</p>	 <p>(Top View)</p>		<p>plastic retainer 18FF-H4</p> <p>marker 18FF-M3</p>

Notes: \* Please refer to the product datasheet if plug-in module is required.

## DIMENSION OF RELATED COMPONENT (AVAILABLE)

Unit: mm

### Retainer

18FF-H1 (metallic retainer)

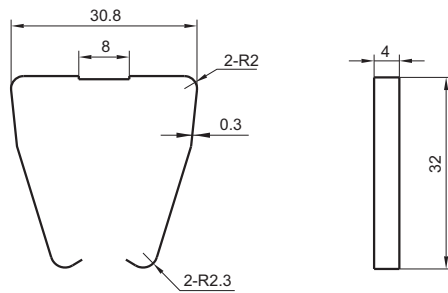

18FF-H2 (metallic retainer)

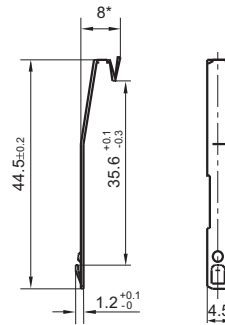

Remark: 18FF-H2 retainer has to be used in sets, please pay special attention while placing the order.

18FF-H4 (plastic retainer)

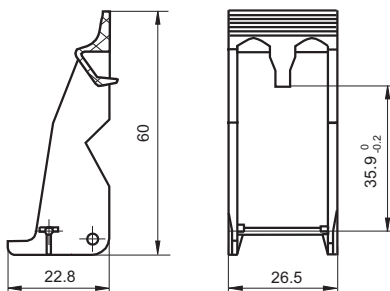

18FF-H5 (metallic retainer)

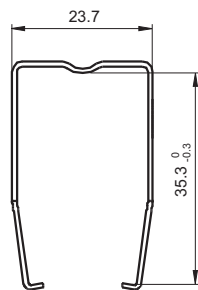

18FF-H6 (metallic retainer)

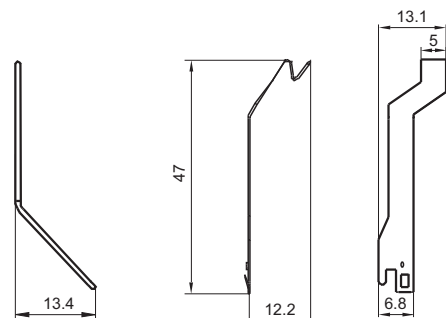

Remark: 18FF-H6 retainer has to be used in sets, please pay special attention while placing the order.

Marker

18FF-M1

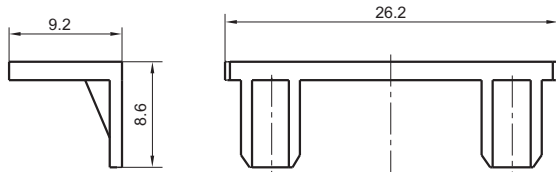

18FF-M2

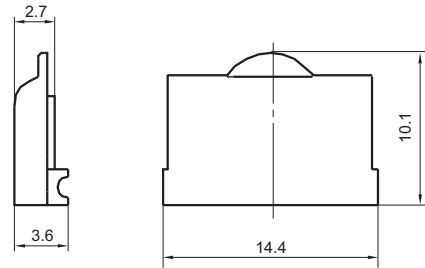

18FF-M3

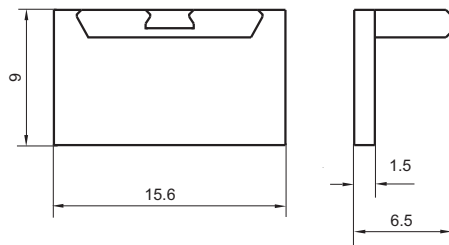

**Things to be noticed when selecting sockets:**

1. Please choose suitable relay socket according to the actual mounting environment, relay contact poles and terminal layout. If there is any query on selection, please contact Hongfa for the technical service.
2. Socket which can be mounted with markers is furnished with a marker; as for other related components, they should be selected separately. Please do give clear indication of the types of relay sockets and related components you choose while placing order.

**Disclaimer**

This datasheet is for the customers' reference. All the specifications are subject to change without notice. We could not evaluate all the performance and all the parameters for every possible application. Thus the user should be in a right position to choose the suitable product for their own application. If there is any query, please contact Hongfa for the technical service. However, it is the user's responsibility to determine which product should be used only.

© Xiamen Hongfa Electroacoustic Co., Ltd. All rights of Hongfa are reserved.